

Objímka odbočky z hliníkové trubky 32 x 20 mm

PPSBP3220

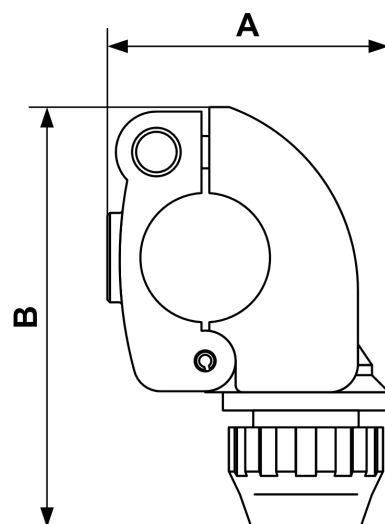

Detaily produktu

Kód	PPSBP3220
EAN 13	3660058243209
Délka (mm)	104
Šířka (mm)	69.5
Průměr (mm)	32 x 20
Hmotnost (kg)	0.210000
Design (materiál)	Aluminum
Maximální tlak (bar)	13 at 40°C

